

Messerschmitt

Systems AG

Hotel Key Card System
On-line EXECUTIVE Version

On-line EXECUTIVE Key Card Systems

by Messerschmitt®
Made in Germany

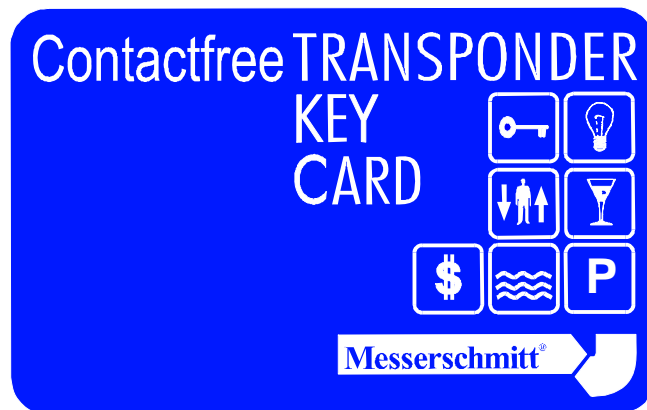

Contact Free Transponder Card

The very latest 13,56 MHz Technology (ISO)

Magnet Card System

Proven Technology

	Page
1. Messerschmitt	4
The Hotel Automation Company	
1.1 Messerschmitt Product Range	6
1.2 Automation Benefits	7
1.3 On-line System Benefits	8
1.4 Benefits: On-line System - Safety Features	9
1.5 Benefits: On-line System - Automation	10
1.6 Advantages at a Glance	11
2. Overview EXECUTIVE System	13
2.1 Card -Technologies	13
★ Transponder Card	
★ Magnet Card	
2.2 Models / Installation-Variations	14
2.3 Contactfree Transponder Card System	15
2.4 On-line System Diagram	16
2.5 On-Wall Installation	17
2.6 Transponder On-line Card Reader	18
2.7 Access Control Reader	19
2.7.1 Special Area or Common Area Reader	19
2.7.2 Internal Area Reader	19
2.8 Transponder Cash Card Reader	20
2.9 Key Card Coder Unit	21
3. Card-Hierarchies and Card Types	22
4. Useful System Extensions	25
5. System Handling and Functions	26
6. Installation, Remote Support via Modem	28
6.1 Remote Support and Maintenance via Modem	28
6.2 Installation Specifications	29
7. INCOS Energy Control Functionality	30
★ References	35
★ Short Fax Enquiry	37

Hotel Key Card System

On-line EXECUTIVE Version

Messerschmitt

Hotel Automation Systems



Messerschmitt Germany Head Office

Experience, Know How and Latest Technologies

Since about 20 years Messerschmitt is one of the leading manufacturer specialised in electronic Ident Card Systems, Access Control, and Energy Control Systems.

More than 1,000 Companies and Hotels are working with Messerschmitt Systems world-wide.

One of the innovative development of Messerschmitt Systems is the "Contact Free Chip Card System" with RF (radio frequency) technology, which provides a maximum of security and comfort. Additionally, Messerschmitt presents its patented Automatic Minibar and integrable Energy Control Systems.

© Messerschmitt Systems® AG, Nuremberg, Germany

Tel: +49 911 91999-0 Fax: +49 911 91999-22

Internet: www.messerschmitt.com

E-mail: info@messerschmitt.com

1 Messerschmitt Systems AG

The Hotel Automation Company

Messerschmitt Systems is the only company to deliver both offline and fully integrated on-line Key Card Systems with Energy Save Automation. As manufacturer and designer of both hard- and software, Messerschmitt Systems has extensive experience in producing state of the art technology to meet the demands of the modern hotel industry. Distribution, customised delivery and installation are managed directly from our own factory, a guarantee for fair and attractive pricing. Local installation and service are managed exclusively by Authorised Messerschmitt Business Partners world-wide.

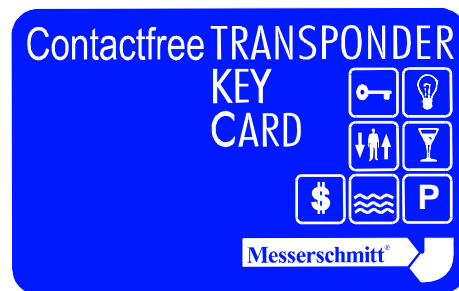

One of the innovative developments of Messerschmitt Systems is "Contact Free Chip Card System", based on RF (Radio Frequency) technology on a 13.56 MHz ISO basis.

This system provides a maximum of both security and comfort and can further be used as a Customer Loyalty Card or a Inhouse Credit/Debit Card. The system is also compatible with the existing patented Automatic Minibar and the integrated Energy Control System.

The Transponder Card combines the most easy handling and highest security for your guests, staff and management.

Radio Frequency Technology is rapidly advancing as the standard choice for modern security systems today.

As a premiere, this brand-new 13.56 MHz has been established a world-wide ISO standardisation. The IATA (Airline Association) is forwarding its world-wide use as well as UPS, DHL, or the US Mail. This means a world-wide break-through of this Future Technology.

Messerschmitt Products

Hotel Automation Systems

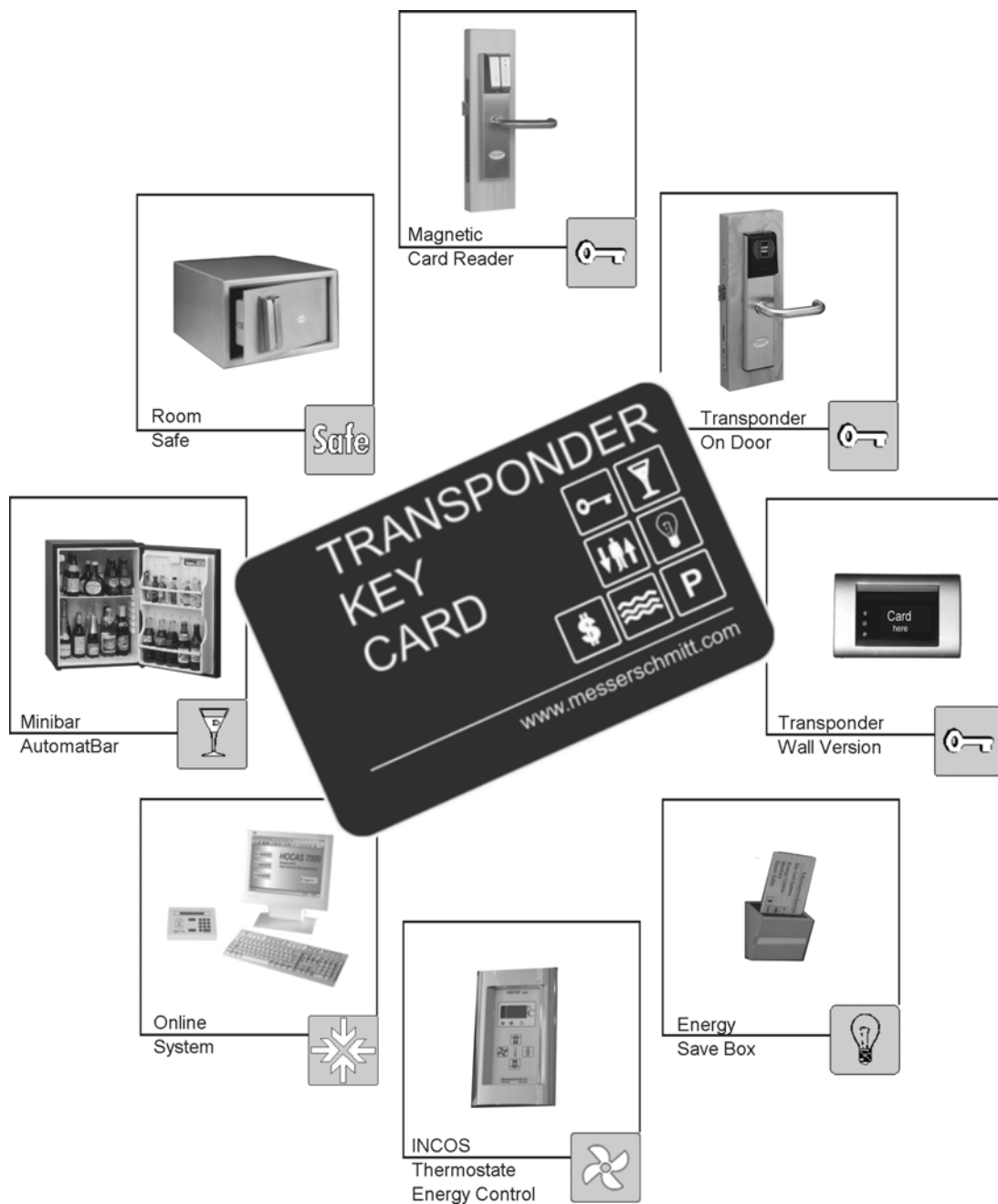

1.1 Messerschmitt Product Range "Multifunctional Systems" with only "1Card"

Hence every single Messerschmitt module provides full compatibility, any on-line structure can be created to fulfil the customer's needs.



Contactfree Transponder Card System



Magnetic Card System



Minibars

- Option:
- Opening control/display
 - User access control with electronic lock

Automatic Minibars

- Automated Billing



Electronic Safes

- Usage Options:
- PIN Code access
 - Key Card or Credit Card access
 - Transponder Card access

1.2 Automation Benefits Fully Integrated Hotel Card System & Energy Control System

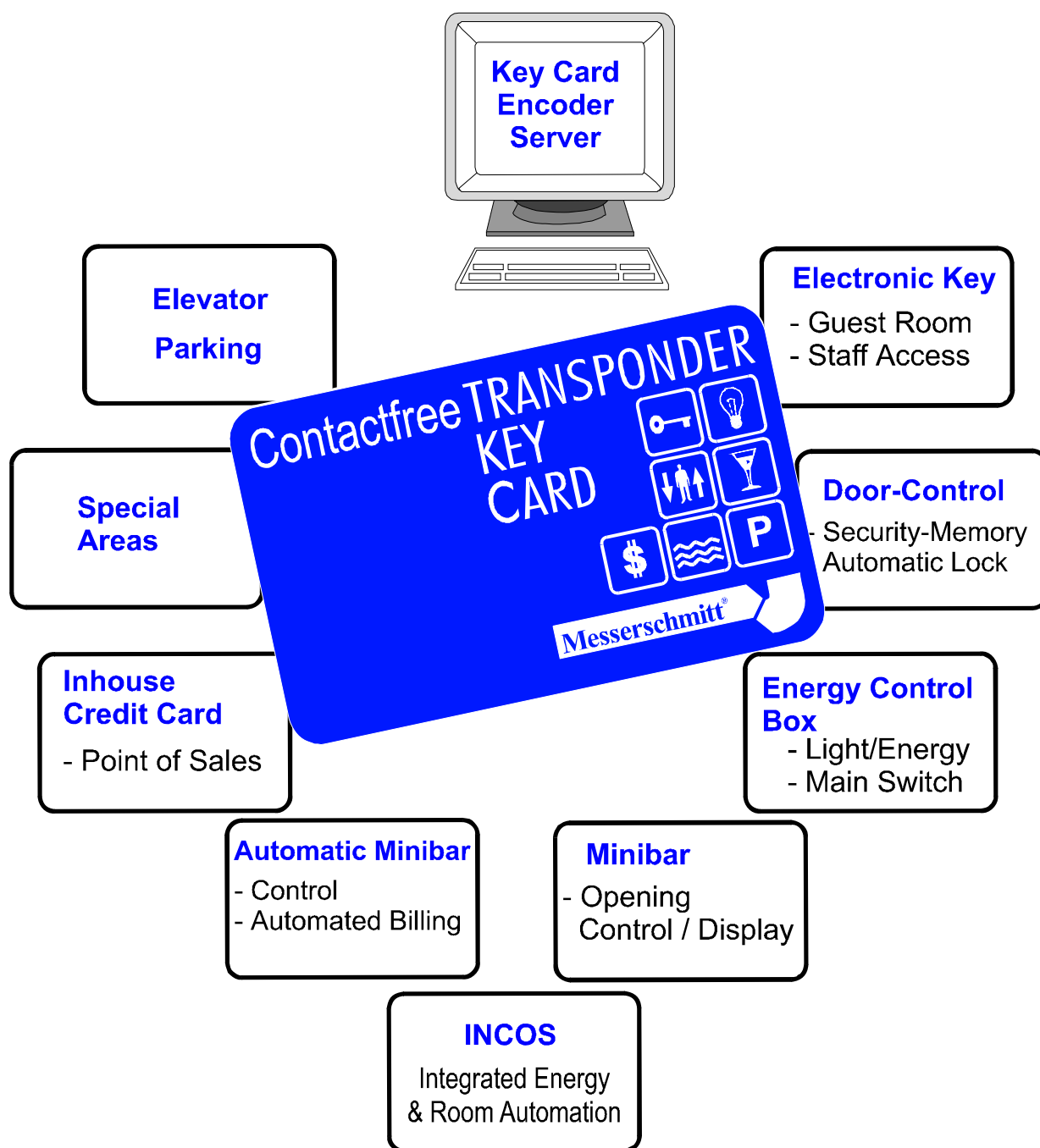

1.3 On-line System Benefits

The trend is to reducing every day cost !

Messerschmitt Systems is specialised in producing "On-line systems".

All rooms are directly connected by an "On-line Bus System" to the central Messerschmitt PC and the Front Office.

Benefits of on-line systems:

- **Reducing Investments Costs**
by integration of "Multi Functionality" in one system instead of purchasing "Single Systems"
- **Automation of Controls**
reduction of Staff Costs by System Automation
as e. g. Electronic Energy Control Systems
- **High Security Level**
For the guests and the hotel management
- **Reduction of Energy Costs**
by Energy and Automatic Room Control

1.4 Benefits: On-line System

Safety-Features

- **Permanent Authentic Burglar Alarm Control**
with immediate real time alert information to the Central Server PC
- **Permanent Door Open Control and Alarm**
with immediate real time alert information to the Central Server PC
- **Automatic High-Security-Hotel-Lock**
whenever closing the door the dead latch **automatically extends by 20 mm and deadbolts the door**. The door is locked automatically at any time and mechanically secured against manipulation. This function provides **active mechanical security at any time**.
- **Automatic Card Cancellation from Server-PC**
of **lost, stolen, or misused** guest and staff key cards at respective card readers within seconds from the Server PC.
- **Automatic Modification of Access Levels and Special Areas** at all card readers (especially staff cards) from the central Server-PC from reception
- **Long Term historical Security Data Memory**
Recording of all entries, a selective printout of any events and dates, persons, or doors is possible
- **Hot-Line Real-time Remote Services and Support with modem** for remote maintenance. Includes remote-diagnostic software and program updates

1.5 Benefits: On-line System

Automation

- **Central Automatic Locking of Guest Key Cards**
after check out, or if stolen, lost, or misused
optional individual check out time
- **Central Administration of all Staff Authorisations**
for In-house Special Areas,
with individual access specification
- **Electronic Minibar-Control**
permission of minibar usage will be individually
coded onto the guest card at time of check in
- **Energy Control for Guest Rooms**
(Energy Room Control Box)
- **Absence or Presence Status of the guest**
(Energy Control Box)

1.6 Advantages at a Glance

The EXECUTIVE System is an on-line system using either traditional Magnetic-stripe Cards or up-to-date Contact free Transponder Cards. The EXECUTIVE System can be installed on-door or beside the door, on-wall.

The EXECUTIVE System means the following advantages:

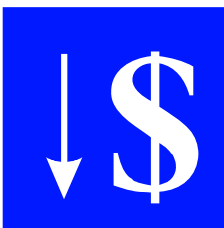

Up to 20 % reduced Investment Costs



by using Messerschmitt Modules

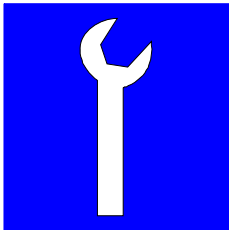

Simple and Quick Installation and Maintenance



Customised System Packages



Installation Guides for Upgrading

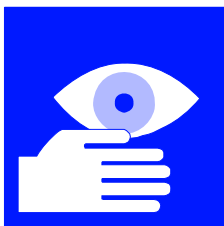

Highest Security Standards



Lost or not returned Key Cards are automatically cancelled at the central server PC.



High Security against manipulation by security pre-coding with system ID and checksum control



Long Term History on Hard Disk



Which Guest / Which Staff Card



Date, time and door

1.6 Advantages at a Glance

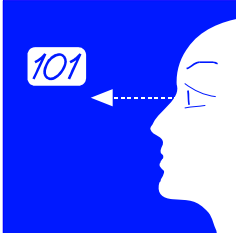

Intelligent Long Time History on Hard Disk

- Automatic date and time control
- Automatic card expiration control
- Automatic cancellation after Check-out



Interface to PMS Computer Systems

Supported Systems:
Micros-Fidelio, HIS, Hogatex, Protel, INTRAC.

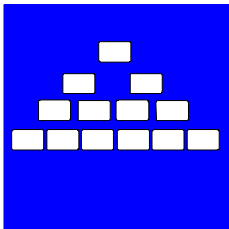

Special Areas Access Control

Up to 40 additional Special Areas, e.g.
Storerooms, night entrance, parking area, elevators, staff access, etc. These configurable areas are in addition to the standard 11 available hierarchies for key cards.

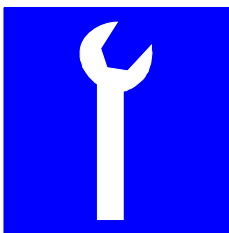

Quick and easy Installation

- Reader integrated batteries for approx. 20.000 entries or approx. 2 years
- optional external power supply 12VDC

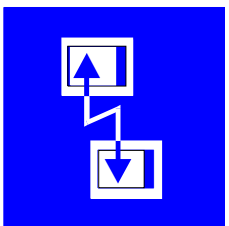

Central Hotline Support and Maintenance with Remote-Support-Modem-software

2 Overview

EXECUTIVE on-line System

2.1 Card - Technologies

Two different Key Card Technologies are available:

Magnetic Stripe Technology

World-wide acceptance and installations

Contact Free Transponder Technology

The very latest in access control technology on 13,56 MHz basis – extreme ease of use.

Messerschmitt Systems offers unique upgrade opportunities whereby the installed technology can be upgraded with minimal installation efforts. I.e. Magnetic strip technology can be upgraded to Transponder Technology.

This is exclusively possible through the modular construction of the Messerschmitt components.

2.2 Models

Installation-Variations

On-line readers can be installed both as "On-door Models" (battery powered), or as "On-wall Models" with centralised external power supply.

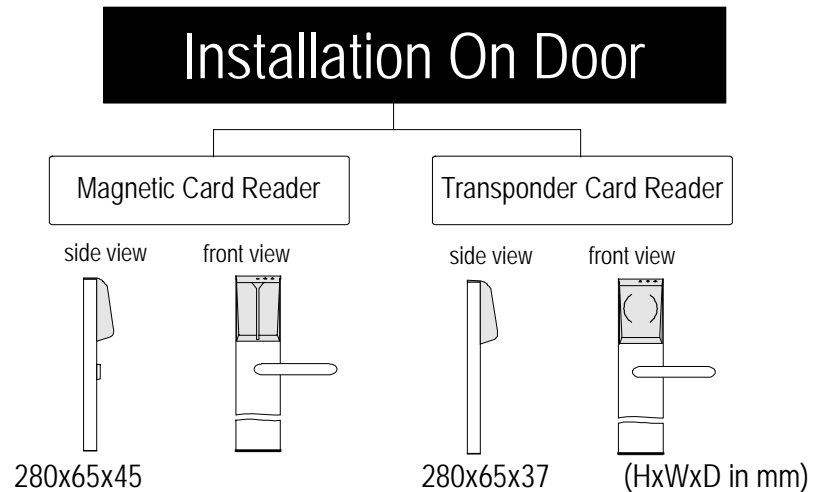

The off-line reader system is supplied with battery packages. For on-line operation the readers are supplied with power supply and are connected to a ringbus. The wiring for the ringbus is installed with a cable bridge through the door.

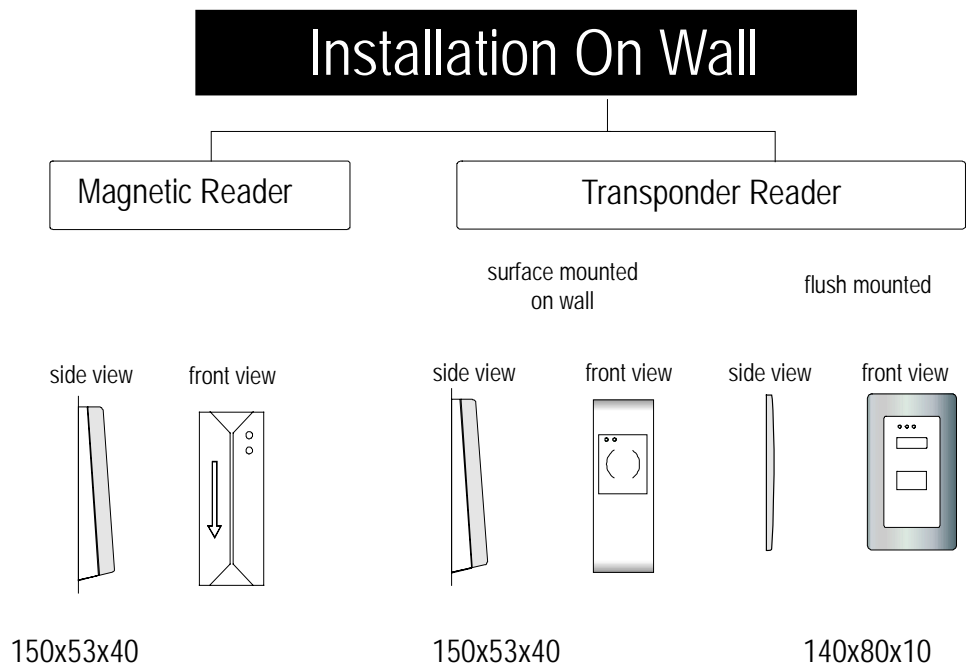

2.3 Contactfree 13.56 MHz Transponder Card System

Standard system components on-door:

- 1 On-Door Transponder Card Reader*
- 2 High security escutcheons with handles stainless steel
Available finishes : Brushed Stainless Steel
Polished or Satin Brass
Polished Stainless Steel (like Chrome)
- 3 Server & Card Encoder for Key Card Coding

Options:

- 4 Hotel High Security (Automatic) Lock
- 5 Interface to PMS (Front Office System)
- 6 brand-new DIN/EN compliant fire-proof escutcheons and DIN/EN lock-case

* Readers are also available for "wall-mounting" (flush or surface mounted) , cf. page 17

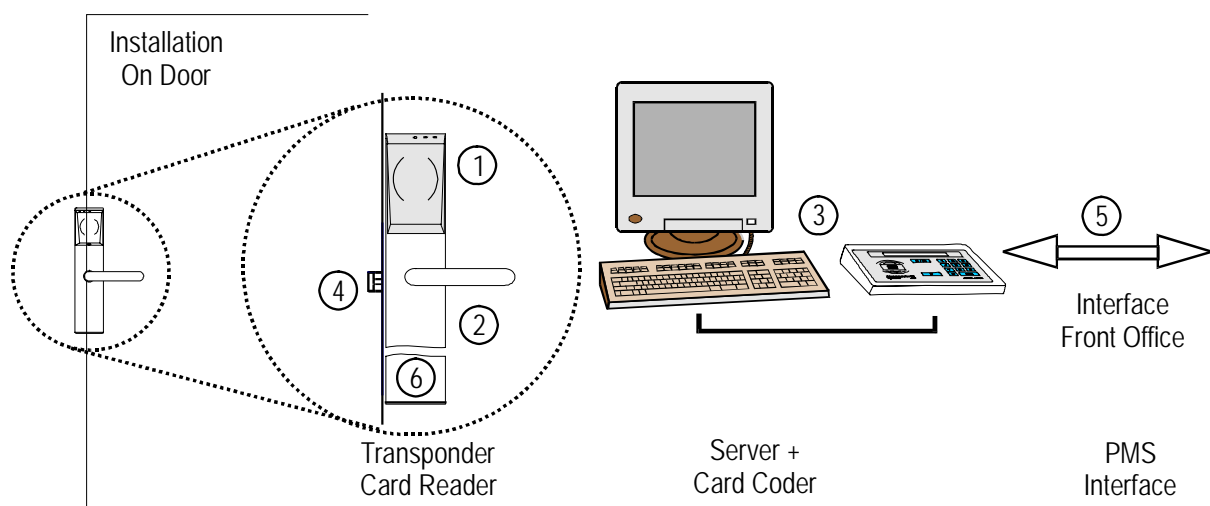

2.4 On-line System-Diagram

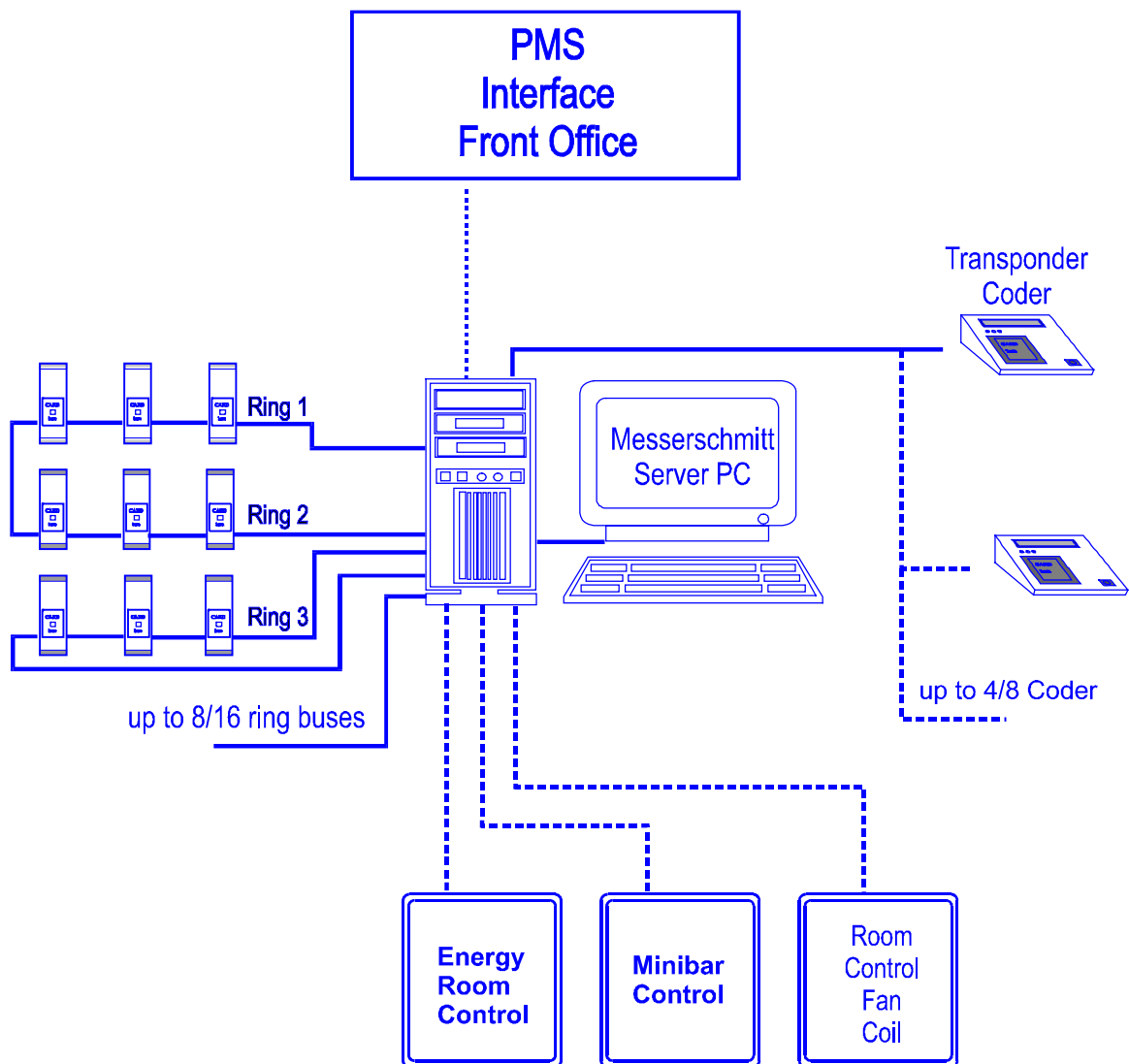

Annotation: Card Readers for wall-mounting (flush or surface mounted) are shown here.

2.5 On-Wall Installation

Optionally, readers can be mounted on-wall.
This allows mounting of custom escutcheons and locks or (in case of refurbishment) keeping the existing escutcheons.

System Components On-Wall:

- 1 Wall-mounted card reader controls electronic door release (strike)
- 2 Electronic door release with built in manipulation safety
- 3 Compact Card Encoder for Key Card Coding
- 4 Interface to PMS (Front Office System)

Additional Optional Extras:

- 5 brand-new DIN/EN compliant fire-proof escutcheons
- 6 On-line connection to ring bus

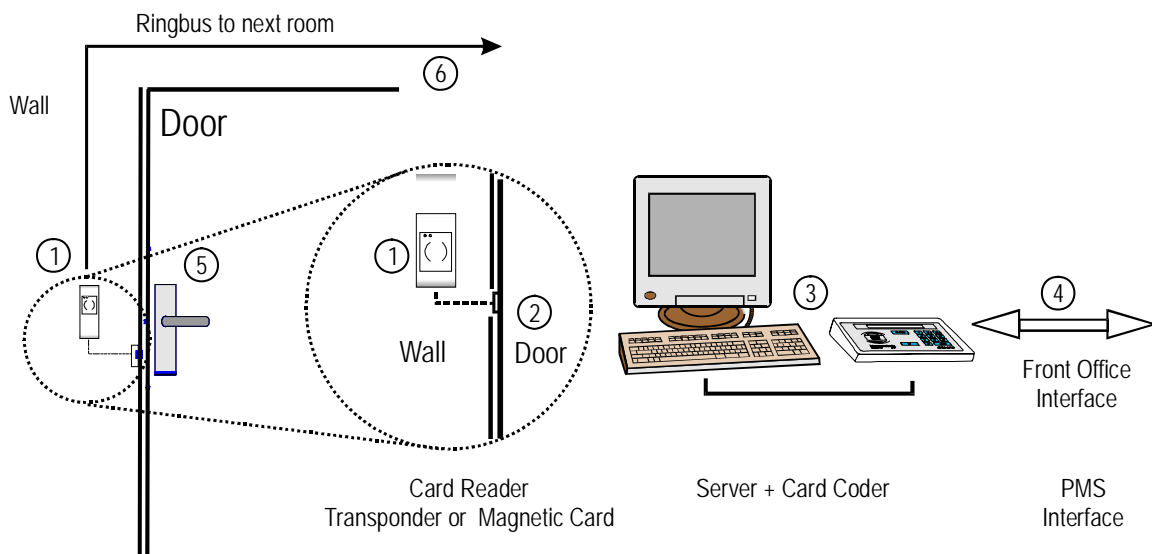

2.6 Transponder On-line Card Reader On-Wall Installation Alternatively: Flush Mounted

Transponder On-line- Reader Units are directly connected by ring cable to the Central Server-PC. Therefore these reader units offer a wide range of additional benefits.

The On-line Card Reader Units are mounted directly onto the wall besides the door or, alternatively, on the door, and are connected to an external power supply (12V DC).

The Reader Unit itself controls the different special access and safety-codes. If the On-line function or the ring cable is broken, the Reader Unit itself works autonomously by full access control functions. That means, the guest or your staff never experience any problems or reduced security.

Flush mounted



Measurements: (WxH): 80 x 140 mm
Depth Built-in box: approx. 70 mm

On Wall – surface mounted

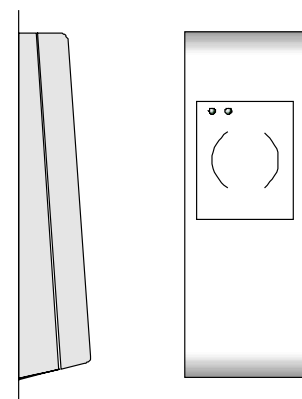

150x53 mm
Depth: approx. 40 mm

2.7 Special Areas or Common Areas Access Control Reader

In Addition to the conventional Guest Room Reader models, the following Readers (with special software controlled functionality) are available:

2.7.1 Special Area Reader or Common Areas

Used in general access areas for guests and staff
e. g. for the following areas:



**Elevator Access,
Specific Floor Access**



**Restricted free of charge access
e.g. Fitness area**



Minibar User Access

2.7.2 Employee Access Control Internal Areas

These Readers are individually configurable for room and time zones, and can be used e. g. for:



Staff Office Access, Back Office Access

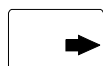

Storerooms, Staff Entrances, etc.



Main and Side Entrances

2.8 Transponder to be used as Cash Card Reader

The Transponder card is the ideal medium for automatic payment systems. The card is charged or loaded upon pre-payment for use within the Hotel.

Alternatively, the card can also be used as an in-house Credit Card with on-line accounting directly to the guest account within the Front Office PMS System. In this instance the Key Card Reader is directly attached to the POS System.

Transponder Cash Card Reader Uses

The Transponder Card is an ideal automation method for chargeable guest services. The Card can be used for the following services:



Wellness Centre

Sauna, Fitness area,
Swimming Pool.

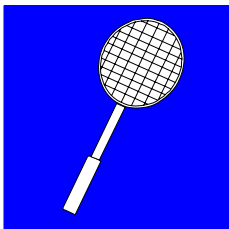

Sport Facilities

Tennis, Squash,
Bowling, etc.

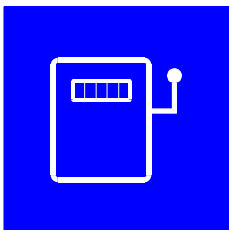

Gaming Machines

Billiards, Darts, etc.



Direct POS connectivity

Cashiers, as e.g. Micros, Schultes, Gastrofix.
Vending machines, as e.g. Wurlitzer, Mars, Coca-Cola.

2.9 Key Card Coder Unit

Key Card issuing at Check-In

Key Card Encoder handling at Check-In is quick and easy with a Windows 98/NT/2000 based user interface. Up to 8 (16) coding stations can be operated simultaneously using the encoder network.

For security purpose, all encoder transactions are recorded in a log file. The encoder stations are equipped with displays providing operational guidance and can be used for card identification and verification.

Key Card encoding Possibilities:

1. Direct encoding via the Messerschmitt System PC
2. Direct integration to the PMS Check-In Terminal



1. Encoding via the Messerschmitt System PC

At Check-In, the room number and duration of stay are entered. All other data is automatically generated by the System PC. The Key Card is issued and ready for use within seconds.



2. Encoding via the PMS Check-In Terminal

This is the fastest and most elegant method of issuing Key Cards. All necessary data is generated from the Check-In terminal and automatically being transferred to the coding station. This encoding method requires an interface between the Front Office PMS System (Host) and the Messerschmitt System PC.

A Messerschmitt standard interface program for most Front Office Systems is available.

3. Card-Hierarchies and Card Types

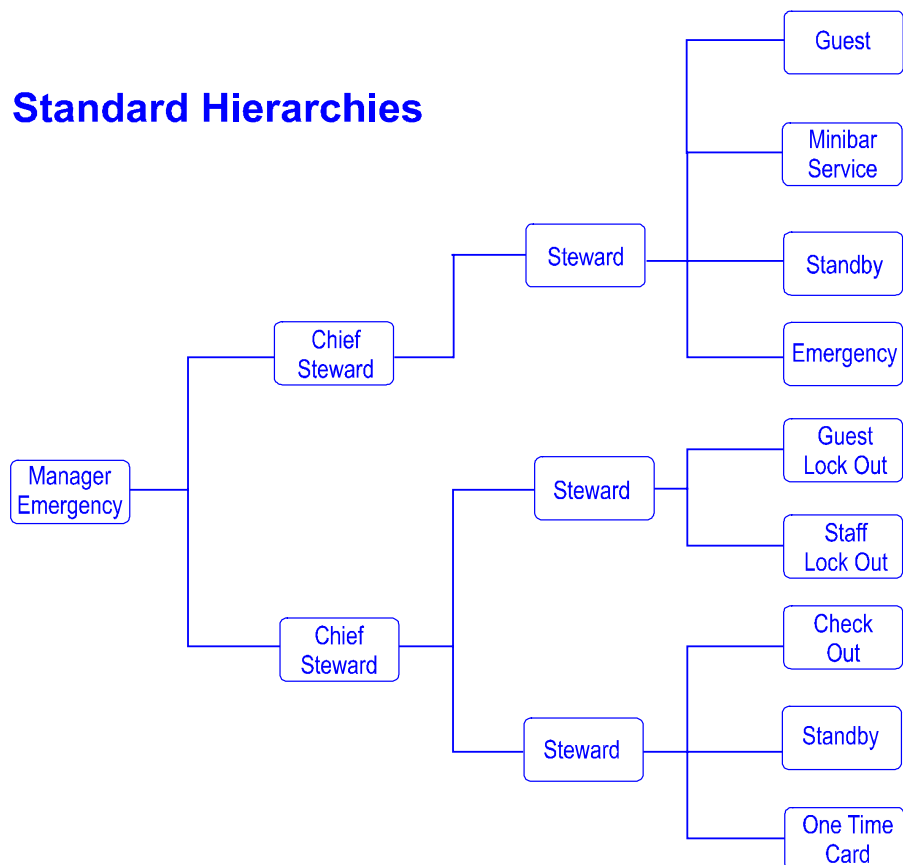

Additional up to 40 free configurable special access areas

Sample configuration:



3. Card-Hierarchies and Card Types

The Messerschmitt Card Coder software is configurable for 11 hierarchical levels and an additional 40 specific access areas:

Guest Card	Coded for a specified date and time period for access to a specific room and / or pre-defined special areas (e.g. sauna, garage, night entrance, etc.)
Steward Card	Coded for a specified number of rooms (e.g. Floor or wing.)
Chief Steward Card	Coded like a Steward Card, but with general access to multiple floors or wings
Manager Card	Access to all rooms and / or special areas
Emergency Card	Access authority identical to Manager Card with additional access to locked „Do Not Disturb „ doors.
One Time Card	One-Time-Access for a specific door for service purpose (e.g. technical maintenance, flower service, etc.)

3. Card Hierarchies and Card Types

Standby Card	Emergency back-up for guest cards to be used in case of Coding Unit failure at reception. A Standby Card is prepared for each guest room at system set-up.
Minibar Card	Card for minibar service staff only.
Guest Lock-Out Card	This card is to preventing guest access to a specific room and contact the Hotel Reception.
Check-Out Card	Service Staff Card for departure day usage. Use of this card invalidates the current guest card.
Staff Lock-Out Card	Access denial for all staff cards (e.g. sealing a room after a crime.)
"Special Area" Card	The configuration of up to 40 special areas enables the internal organisation of specific access areas such as: Offices, Storerooms, Sauna, Fitness Centre, Garage, Elevators, Club Floors, etc.

4. Useful System Extensions

Special Readers

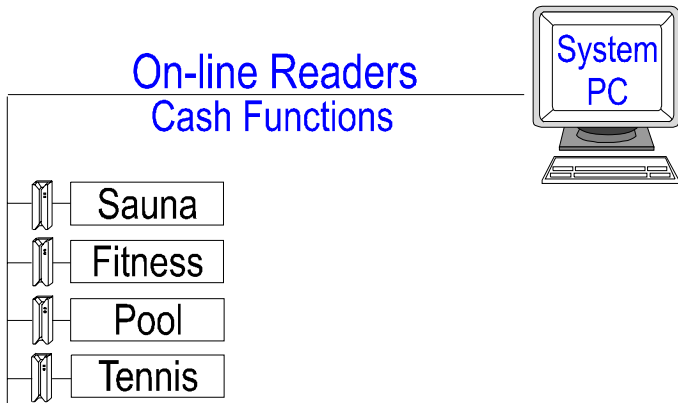

Room Reader

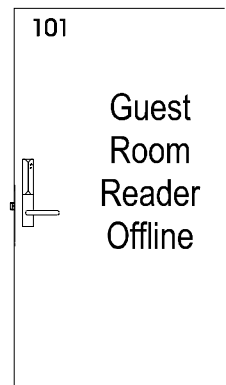

Points of Sale

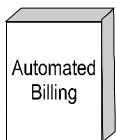
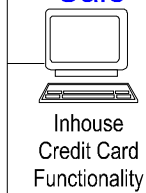

Automatic Minibar



Parking Motor Reader



Minibar

User control
User indication

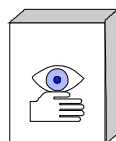

Elevator Control

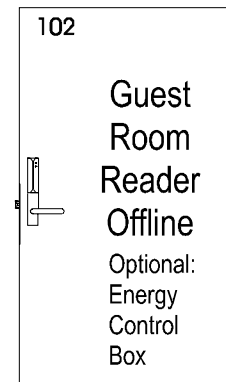
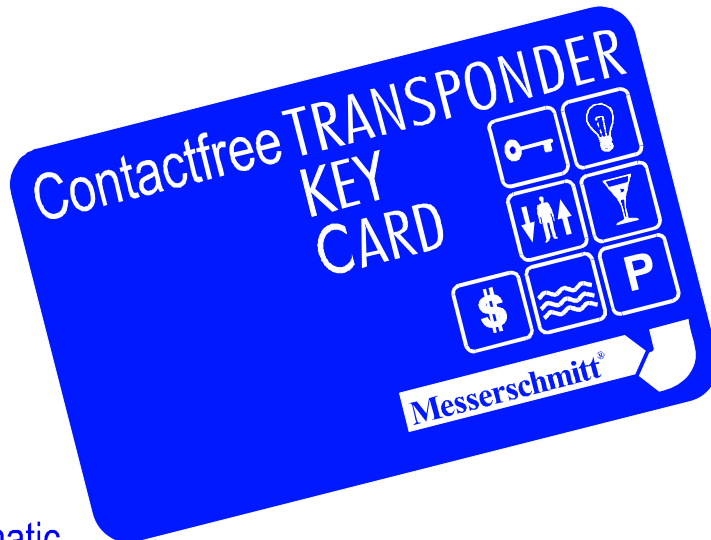
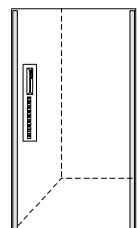

Access Control

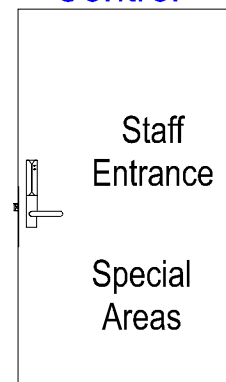

5. System Handling and Functions



Guest card encoding at Check-In

A new Key Card is issued for each guest, for the duration of their stay, at Check-In. The Key Card is automatically invalidated at the end of stay, avoiding potential security risks should the Guest forget to return the Key Card. Subsequent Guests receive new Key Cards valid for the duration of their stay.



Continuous re-cycling of Key Cards

Used Cards are returned to the reception at check-out and can be coded again for another Guest. This system reduces Card cost and is environmental friendly.

The Key Cards, in international Credit Card format, are delivered in recyclable plastic and can be printed with Hotel or Sponsor logos.

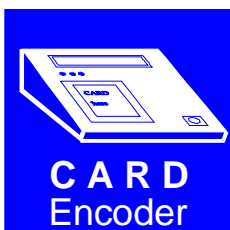

Automatic Card-Encoding at the Check-In Terminal interface

Through the use of an interface between the Messerschmitt System PC and the Front Office PMS system, Key Cards can be encoded automatically at Check-In. If there is no interface installed, Key Cards are encoded directly on the Messerschmitt encoder PC with short-term input of room number and departure date.



Contact Free Transponder Key Card

These security Key Cards should also be returned to the reception at check-out, just as mechanical keys are returned upon departure. These Key Cards are meant for constant re-coding and re-using.

Reception Staff should request the returning of the Key Card at check-out. As a reminder to guests to return the Key Cards, Key-Rings can be attached or instructions printed on the card.

5. System Handling and Functions

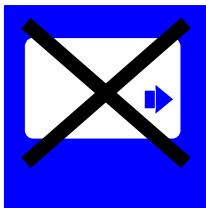

Automatic Cancellation of Key Cards

Each card is automatically invalidated either by expiry date or by the arrival of a new guest using a new card at the door reader.



Each Card is absolutely unique – up to 4 billion variations

Each Hotel is configured with its own unique facility code. Each Transponder Card is created with its own unique code out of 4 billion variations.

For security reasons, cards are delivered in a pre-coded status. This method prevents manipulation and a repetition of card codes, and increases security considerably.



Card Access Levels for Hotel Staff

The system is configured to allow customised definition or updating staff card access levels at the special area readers for internal access control.

All readers are, with the exception of the Room Readers, defined as Special Area Readers. These Readers are configured with extended functionality to enable or disable access to specific areas.

This extended functionality is configured on the System PC and is activated through initialisation of the Special Area Readers. After initialisation, all invalid cards will have access denied.

6. Installation, Hot-line Remote Support via Modem

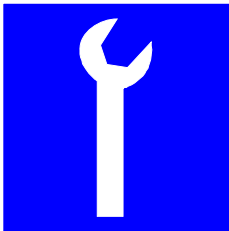

System Installation

The installation of the offline system is as easy as that of a traditional mechanical lock system (please refer to the installation manual).



Messerschmitt Supervised System Installation and Training

System Installation can be handled by local sub-contractors or, respectively, by trained Hotel Technical Staff under supervision of a Messerschmitt Systems Engineer to save cost.

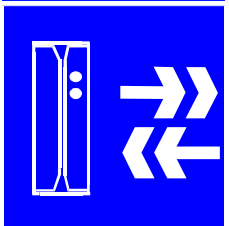

Card Reader Replacement Service Contract

Defective Card Readers can be replaced within minutes by hotel staff. Considerable cost saving for emergency technical service personnel can be achieved with the Messerschmitt Reader Replacement Service Contract. Defective readers are returned directly to the factory or local Business Partners for repair at either fixed rates or as part of an all inclusive Service Contract. One of the additional advantages in signing a Contract is that a permanent supply of Replacement Readers is kept directly at the Hotel premises for immediate use if necessary.

6.1 Remote Support and Maintenance via Modem

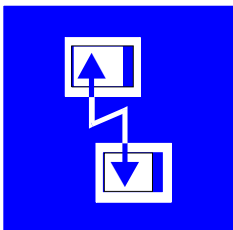

This is the most cost effective method of support which includes diagnostic software and updates for trouble shooting. Remote support contracts include all necessary hard- and software free of charge.

6.2 Installation Specifications

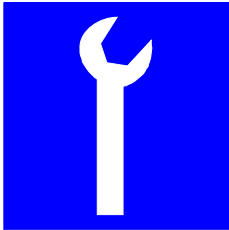

Installation of On-Door or Off-Door Readers

The Reader is usually mounted directly on the door which is the fastest and most efficient method of installation. Installation Specifications, Instructions and templates for drilling are provided to assist installation staff.

Escutcheons must be mounted according to Messerschmitt Specifications by either local contractors or trained Hotel Technicians.

Full Installation of escutcheons and card reader requires between 30 and 90 minutes depending on specification and condition of the door.

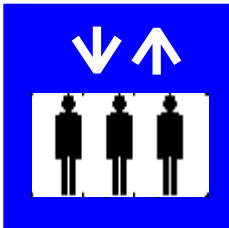

Special Area Readers

Frequently used Special Area Readers, e.g. Sauna, Staff Entrance, etc are usually wall mounted adjacent to the door. They usually have external power supply an UPS.

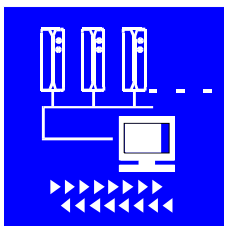

On-line Readers

These conditions also apply to cash-readers which are connected on-line to the System PC or with the POS system for in-house credit card functionality.

Wall mounted Readers provide a potential free contact for connecting an electric door release/striker plate.

Electric Door Release

Door suppliers or sub-contractors can configure the release contact individually. Messerschmitt can supply specific electric striker plates with specific power and security functionality.

7. INCOS – Energy Control Functionality

The energy consumption of guest rooms can be monitored automatically and according to occupancy with the Energy Control Box. Current room occupancy is monitored by engaging the Key Card in the Energy Control Box. Energy consumption of the following outlets is monitored:

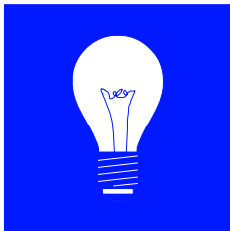

Lights and Power

- Minibar
- Heating
- Air-conditioning

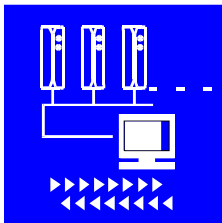

On-line Automation & System Benefits

The on-line system allows ultimate occupancy dependant energy consumption control. The Guest controls energy consumption fully automatically by engaging the Key Card in the Energy Control Box. When entering the room, a single foyer light is lit to help the guest orientating.

Deployment of Energy Control Systems is rapidly increasing world-wide and will eventually become a standard implementation for all hotels.

INCOS

Specific Energy & Room Control Brochure for:

**"Room Energy Management
Building Control Functionality"**

This Brochure is available upon request or can be downloaded from the Messerschmitt web site: <http://www.messerschmitt.com>

Hotel Card System EXECUTIVE Version

Messerschmitt
INCOS
Energy & Automations System

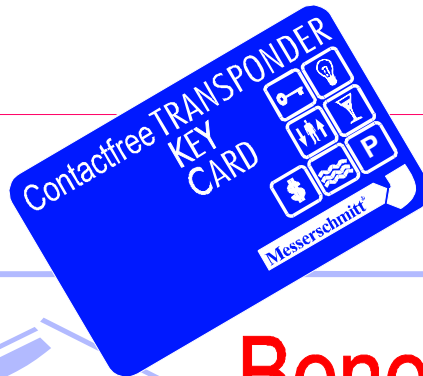

PHANTASIA
Hotels & Resorts

Benefits

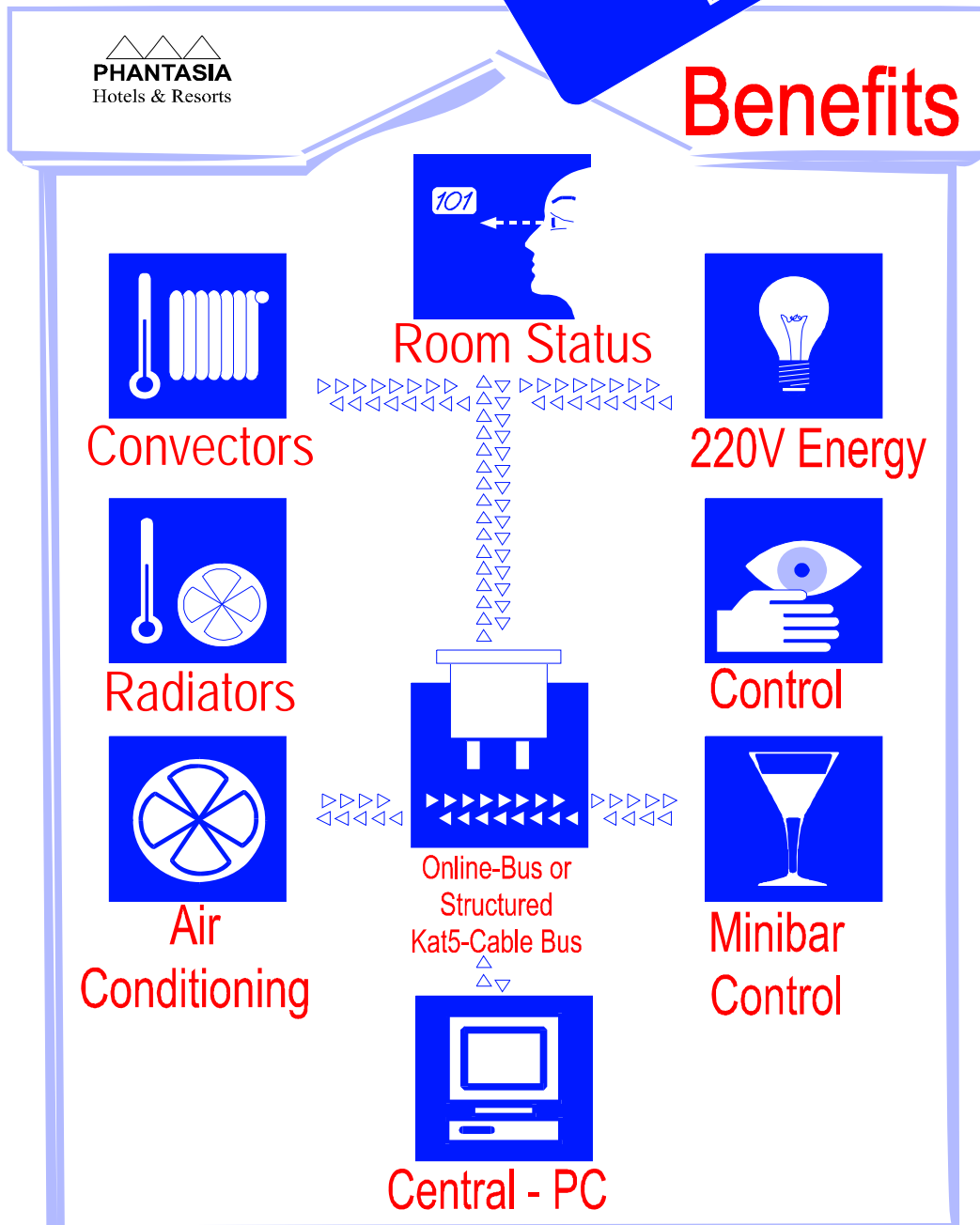

INCOS 3000

with INSTAT 2000 programmable (off-line)
Thermostate User Panel and separate control unit
For heating and cooling control dependent on the guests presence

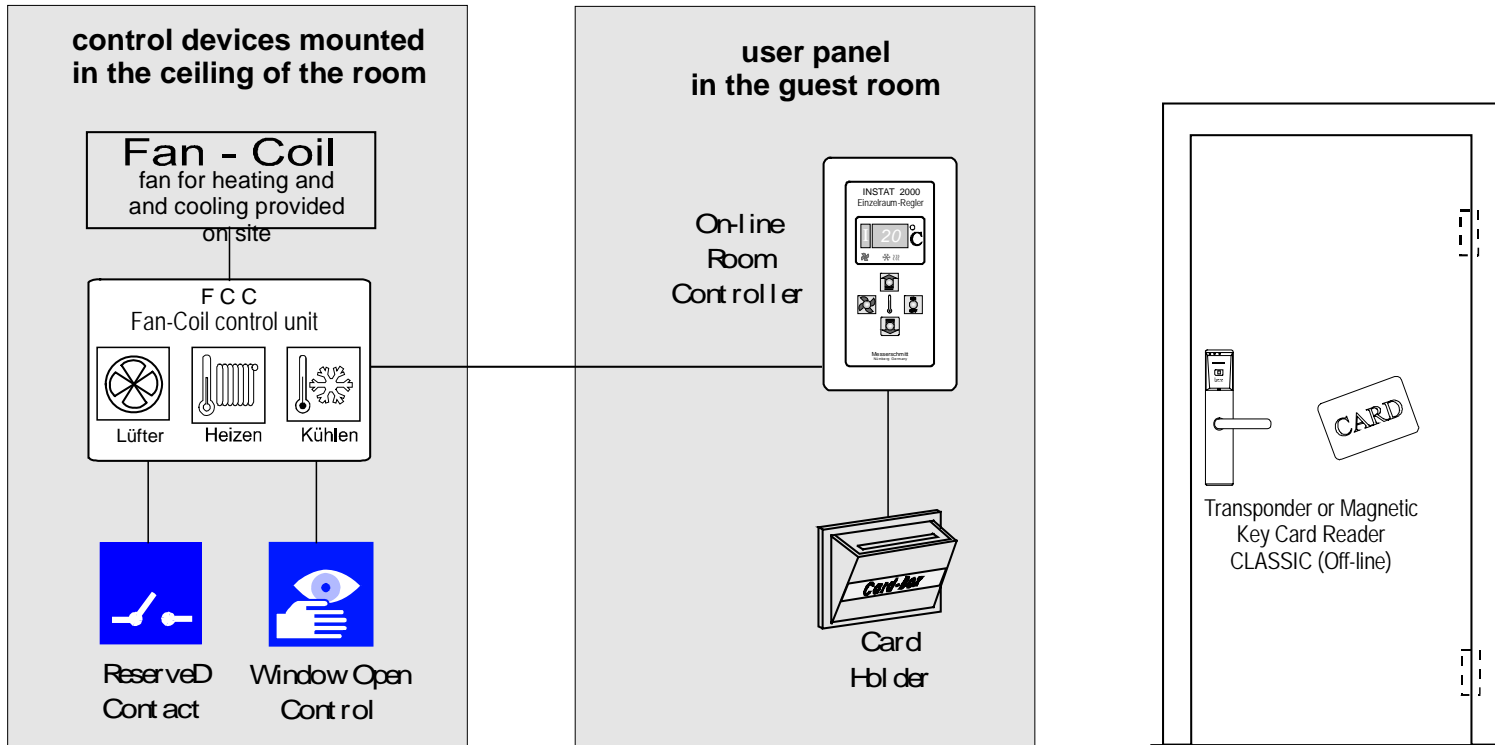

Hotel Card System

EXECUTIVE Version

INCOS 5000 On-line

INSTAT 2000 Room Control Panel - control over on-line bus cable
with separate Fan Coil Control Unit

Heating and cooling control dependent on the guests presence

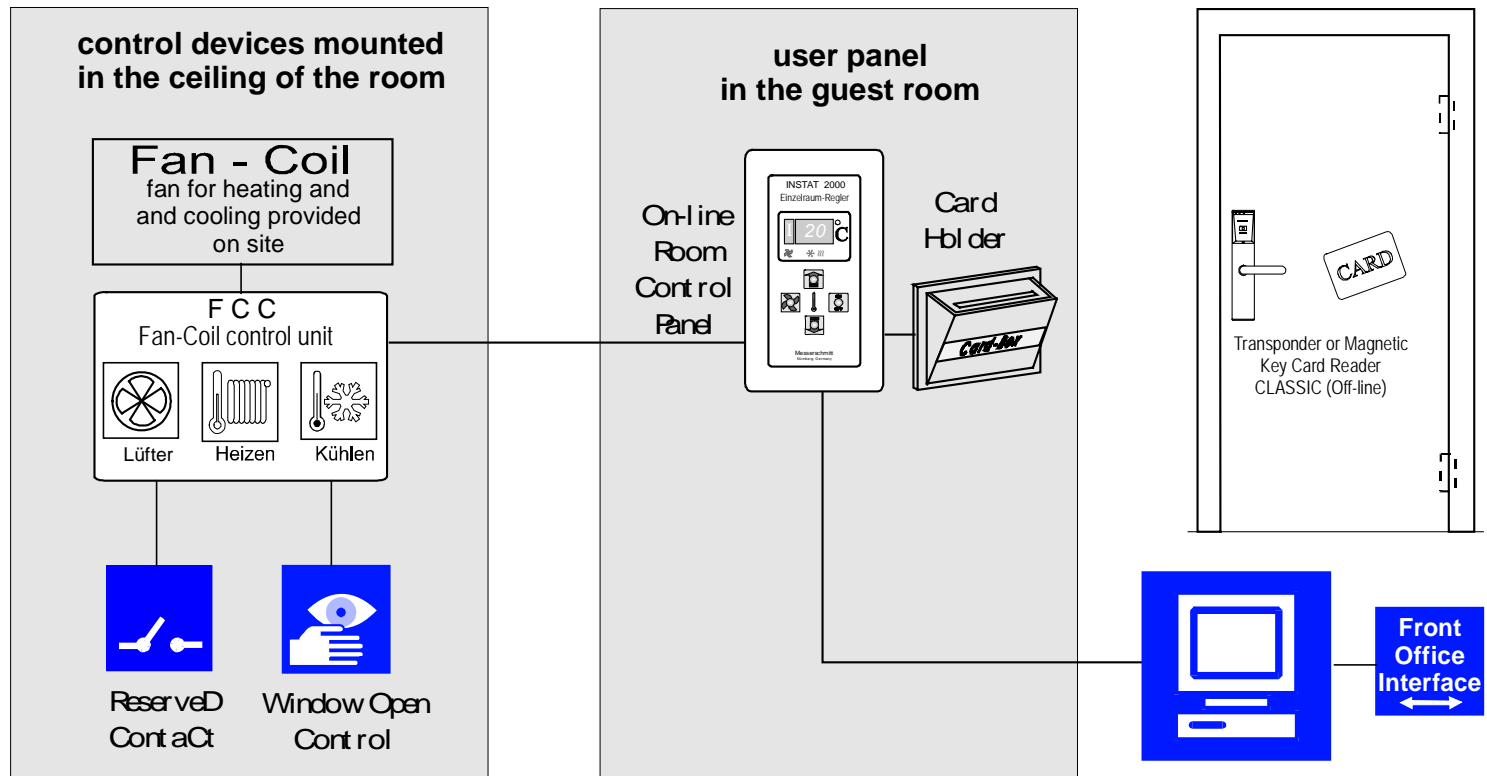

V35.0

Economies & Benefits INCOS.



Online
Integration
Concept

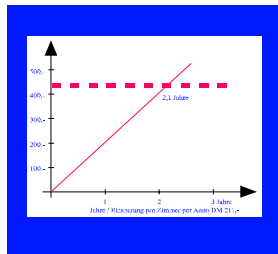

Economies



Benefits



Easy Handling



Top Card

References



Dubai

上海錦遠文華大酒店



Shanghai JC Mandarin



U.S. Airbase
Ramstein



جميرا انقوناشونال

JUMEIRAH
INTERNATIONAL



References



HOTEL
PRIBALTIYSKAYA

St. Petersburg



MARITIM



Lindner Hotels

SHORT TELEFAX INQUIRY

To Messerschmitt Systems Nuremberg/ Germany Fax: +(49) 911- 91 999 22	Sender (do not forget to fill in) Hotel: Name: Function:..... Tel.: Number of Rooms:
-------------------------------------------------------------------------------------------	---------------------------------------------------------------------------------------------------------------------------------------------------------------

We are interested in the following:

- Send us detailed information as marked **URGENT**
 Please call me

Products

	Info	Offer
<input type="radio"/> Hotel Card System, CLASSIC- off-line	<input type="radio"/>	<input type="radio"/>
<input type="radio"/> Hotel Card System, EXECUTIVE on-line	<input type="radio"/>	<input type="radio"/>
<input type="radio"/> Transponder Card System		
<input type="radio"/> Magnetic Card System		
<input type="radio"/> INCOS 7000 Energy Control & Safe System	<input type="radio"/>	<input type="radio"/>
<input type="radio"/> Room Safe <input type="radio"/> PIN-Code <input type="radio"/> Card use	<input type="radio"/>	<input type="radio"/>
<input type="radio"/> Minibars <input type="radio"/> Minibar User Control System	<input type="radio"/>	<input type="radio"/>
<input type="radio"/> Automatic Minibar (Automated Billing)	<input type="radio"/>	<input type="radio"/>

Remarks:

.....

.....

Visit our web site: <http://www.messerschmitt.com>



Locksmith Co., Ltd.
 Email: sales@locksmith.co.th

Tel: +66 38 301 025
support@locksmith.co.th

Fax: +66 38 301 026
www.locksmith.co.th